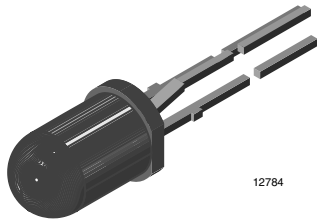


Silicon NPN Phototransistor, RoHS Compliant



DESCRIPTION

BPV11F is a silicon NPN phototransistor with high radiant sensitivity in black, T-1³/₄ plastic package with base terminal and daylight blocking filter. Filter bandwidth is matched with 900 nm to 950 nm IR emitters.

FEATURES

- Package type: leaded
- Package form: T-1³/₄
- Dimensions (in mm): Ø 5
- High radiant sensitivity
- Daylight blocking filter matched with 940 nm emitters
- Fast response times
- Angle of half sensitivity: $\varphi = \pm 15^\circ$
- Base terminal connected
- Lead (Pb)-free component in accordance with RoHS 2002/95/EC and WEEE 2002/96/EC



RoHS
COMPLIANT

APPLICATIONS

- Detector for industrial electronic circuitry, measurement and control

PRODUCT SUMMARY

| COMPONENT | I _{ca} (mA) | φ (deg) | $\lambda_{0.5}$ (nm) |
|-----------|----------------------|-----------------|----------------------|
| BPV11F | 9 | ± 15 | 900 to 980 |

Note

Test condition see table "Basic Characteristics"

ORDERING INFORMATION

| ORDERING CODE | PACKAGING | REMARKS | PACKAGE FORM |
|---------------|-----------|------------------------------|---------------------------------|
| BPV11F | Bulk | MOQ: 3000 pcs, 3000 pcs/bulk | T-1 ³ / ₄ |

Note

MOQ: minimum order quantity

ABSOLUTE MAXIMUM RATINGS

| PARAMETER | TEST CONDITION | SYMBOL | VALUE | UNIT |
|-------------------------------------|---|-------------------|---------------|------|
| Collector base voltage | | V _{CBO} | 80 | V |
| Collector emitter voltage | | V _{CEO} | 70 | V |
| Emitter base voltage | | V _{EBO} | 5 | V |
| Collector current | | I _C | 50 | mA |
| Collector peak current | t _p /T = 0.5, t _p ≤ 10 ms | I _{CM} | 100 | mA |
| Power dissipation | T _{amb} ≤ 47 °C | P _V | 150 | mW |
| Junction temperature | | T _j | 100 | °C |
| Operating temperature range | | T _{amb} | - 40 to + 100 | °C |
| Storage temperature range | | T _{stg} | - 40 to + 100 | °C |
| Soldering temperature | t ≤ 5 s, 2 mm from body | T _{sd} | 260 | °C |
| Thermal resistance junction/ambient | Connected with Cu wire, 0.14 mm ² | R _{thJA} | 350 | K/W |

Note

T_{amb} = 25 °C, unless otherwise specified

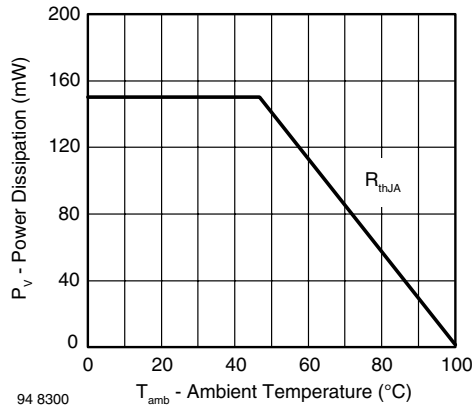


Fig. 1 - Power Dissipation Limit vs. Ambient Temperature

| BASIC CHARACTERISTICS | | | | | | |
|--------------------------------------|---|-----------------|------|------------|------|---------------|
| PARAMETER | TEST CONDITION | SYMBOL | MIN. | TYP. | MAX. | UNIT |
| Collector emitter breakdown voltage | $I_C = 1 \text{ mA}$ | $V_{(BR)CEO}$ | 70 | | | V |
| Collector emitter dark current | $V_{CE} = 10 \text{ V}, E = 0$ | I_{CEO} | | 1 | 50 | nA |
| DC current gain | $V_{CE} = 5 \text{ V}, I_C = 5 \text{ mA}, E = 0$ | h_{FE} | | 450 | | |
| Collector emitter capacitance | $V_{CE} = 0 \text{ V}, f = 1 \text{ MHz}, E = 0$ | C_{CEO} | | 15 | | pF |
| Collector base capacitance | $V_{CE} = 0 \text{ V}, f = 1 \text{ MHz}, E = 0$ | C_{CBO} | | 19 | | pF |
| Collector light current | $E_e = 1 \text{ mW/cm}^2, \lambda = 950 \text{ nm}, V_{CB} = 5 \text{ V}$ | I_{ca} | 3 | 9 | | mA |
| Angle of half sensitivity | | φ | | ± 15 | | deg |
| Wavelength of peak sensitivity | | λ_p | | 930 | | nm |
| Range of spectral bandwidth | | $\lambda_{0.5}$ | | 900 to 980 | | nm |
| Collector emitter saturation voltage | $E_e = 1 \text{ mW/cm}^2, \lambda = 950 \text{ nm}, I_C = 1 \text{ mA}$ | V_{CEsat} | | 130 | 300 | mV |
| Turn-on time | $V_S = 5 \text{ V}, I_C = 5 \text{ mA}, R_L = 100 \Omega$ | t_{on} | | 6 | | μs |
| Turn-off time | $V_S = 5 \text{ V}, I_C = 5 \text{ mA}, R_L = 100 \Omega$ | t_{off} | | 5 | | μs |
| Cut-off frequency | $V_S = 5 \text{ V}, I_C = 5 \text{ mA}, R_L = 100 \Omega$ | f_c | | 110 | | kHz |

Note
 $T_{amb} = 25 \text{ }^\circ\text{C}$, unless otherwise specified

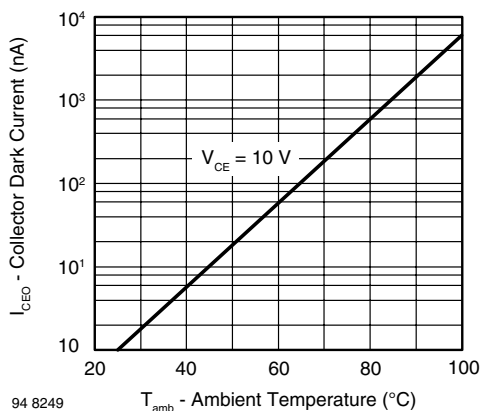
BASIC CHARACTERISTICS
 $T_{amb} = 25 \text{ }^\circ\text{C}$, unless otherwise specified


Fig. 2 - Collector Dark Current vs. Ambient Temperature

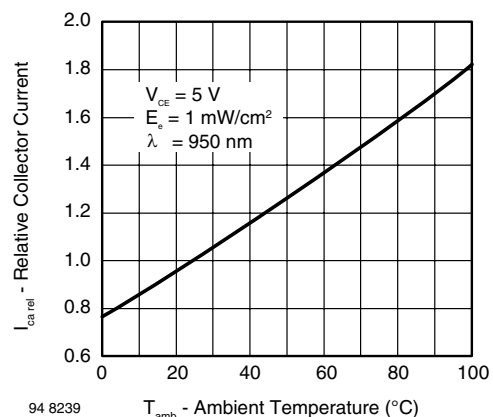


Fig. 3 - Relative Collector Current vs. Ambient Temperature

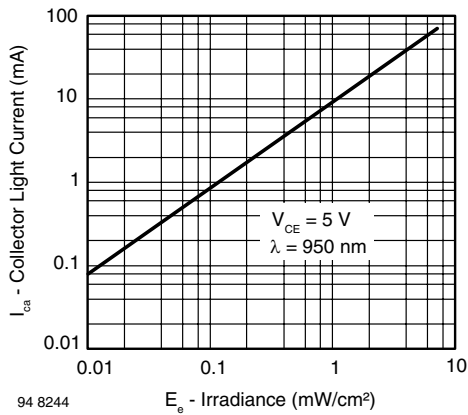


Fig. 4 - Collector Light Current vs. Irradiance

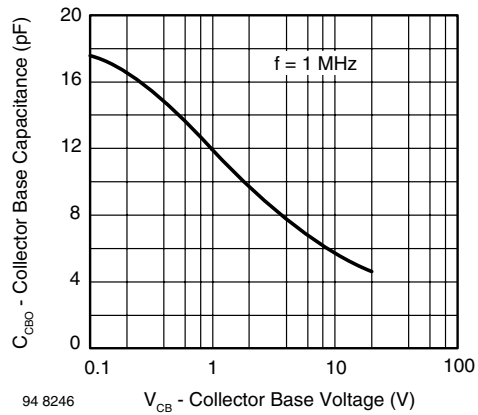


Fig. 7 - Collector Base Capacitance vs. Collector Base Voltage

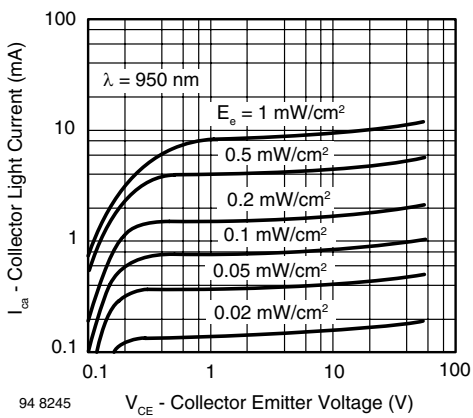


Fig. 5 - Collector Light Current vs. Collector Emitter Voltage

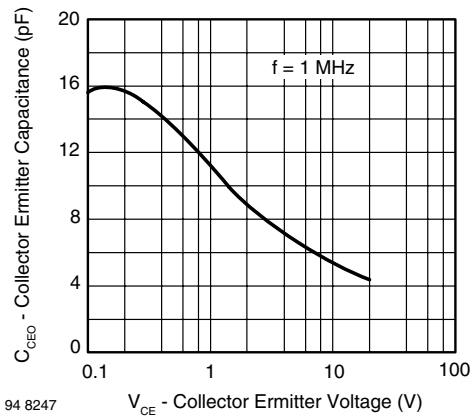


Fig. 8 - Collector Emitter Capacitance vs. Collector Emitter Voltage

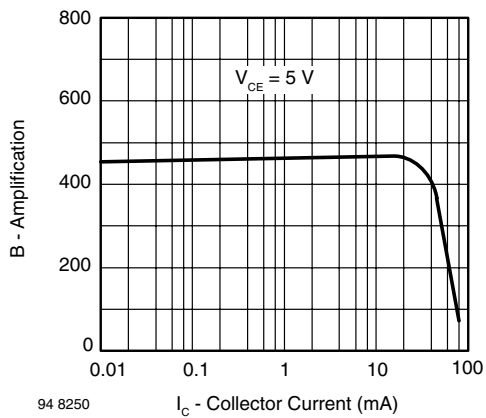


Fig. 6 - Amplification vs. Collector Current

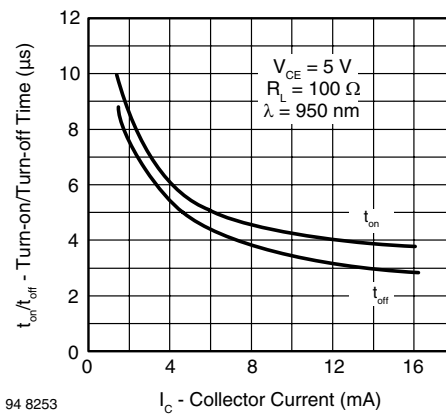


Fig. 9 - Turn-on/Turn-off Time vs. Collector Current

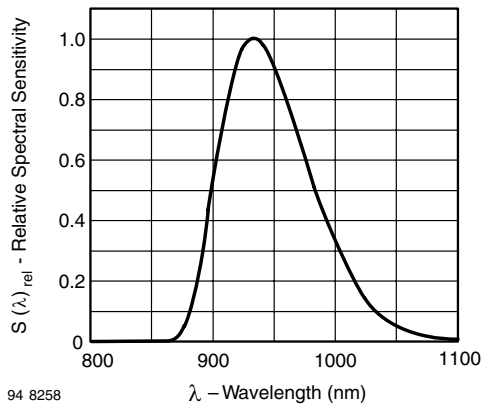


Fig. 10 - Relative Spectral Sensitivity vs. Wavelength

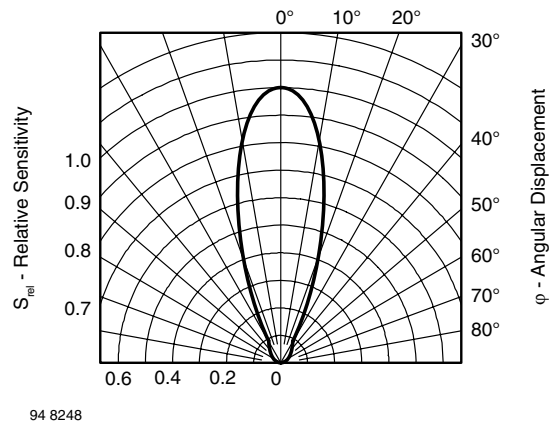
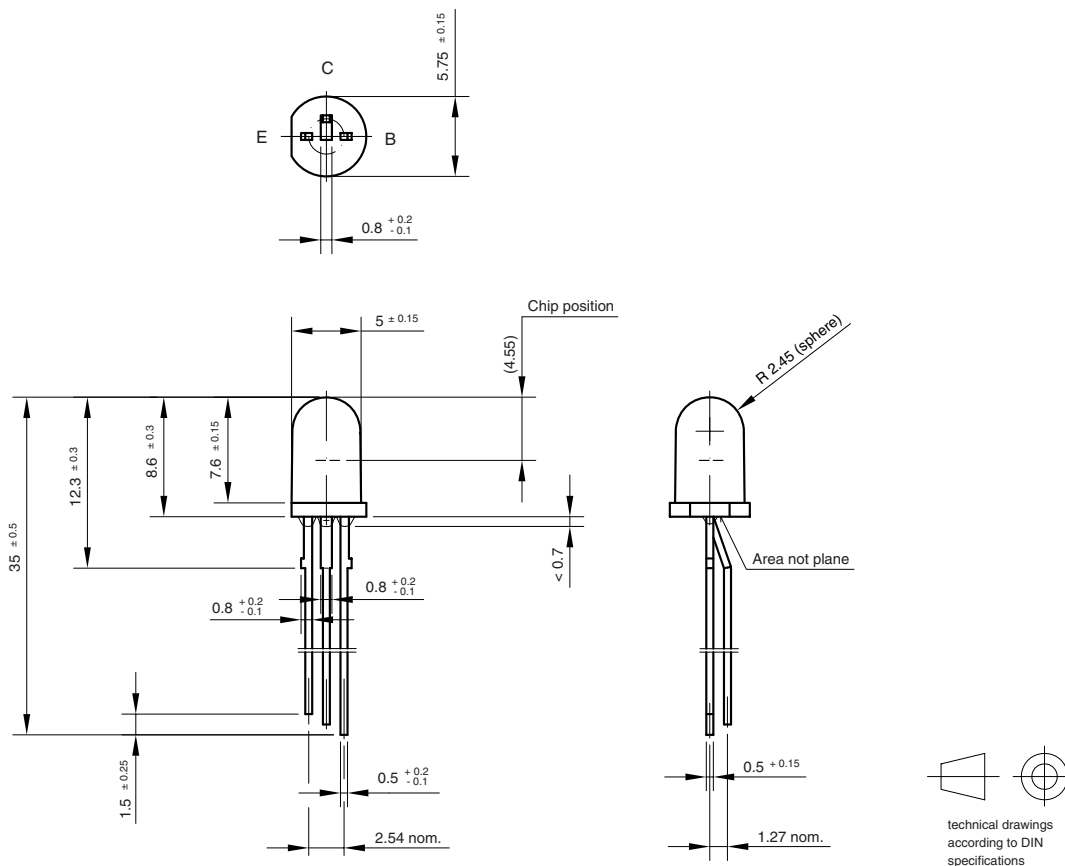


Fig. 11 - Relative Radiant Sensitivity vs. Angular Displacement

PACKAGE DIMENSIONS in millimeters


Drawing-No.: 6.544-5188.01-4
 Issue:1; 01.07.96
 96 12200



Disclaimer

All product specifications and data are subject to change without notice.

Vishay Intertechnology, Inc., its affiliates, agents, and employees, and all persons acting on its or their behalf (collectively, "Vishay"), disclaim any and all liability for any errors, inaccuracies or incompleteness contained herein or in any other disclosure relating to any product.

Vishay disclaims any and all liability arising out of the use or application of any product described herein or of any information provided herein to the maximum extent permitted by law. The product specifications do not expand or otherwise modify Vishay's terms and conditions of purchase, including but not limited to the warranty expressed therein, which apply to these products.

No license, express or implied, by estoppel or otherwise, to any intellectual property rights is granted by this document or by any conduct of Vishay.

The products shown herein are not designed for use in medical, life-saving, or life-sustaining applications unless otherwise expressly indicated. Customers using or selling Vishay products not expressly indicated for use in such applications do so entirely at their own risk and agree to fully indemnify Vishay for any damages arising or resulting from such use or sale. Please contact authorized Vishay personnel to obtain written terms and conditions regarding products designed for such applications.

Product names and markings noted herein may be trademarks of their respective owners.